

mariz



Stylish, durable, compact  
laminated worksurfaces

CARYSIL

# Welcome to mariz surfaces...

Introducing our new range of compact laminate worktops, the ultimate solution for your kitchen or workspace needs! Made by compiling layers of decorative paper and resin that are fused together under pressure, our worktops are resistant to impact and heat, moisture resistant and give long-lasting performance, offering unparalleled durability within the kitchen.

12mm compact laminate

Eight on trend décors to choose from  
(White and black core dependent on décor choice)

Innovative offering with custom options

Bespoke cut out service available



# The mariz difference

We know that the cutting and preparation of compact laminate can be an issue on site so we aim to take away as much of the work as possible. Whilst we cannot prepare the final joint, we have a range of solutions to make life a lot less complicated.

Not only do we have a wide selection of standard-sized worktops and breakfast bars – all with edge preparation – the **mariz** range includes much more. Upstands and splashbacks are available in various sizes and two thicknesses, we even have a full island size for the true open-plan living space.

As you would expect from CARYSIL we also have a superb collection of sinks combined with **mariz** in our unique sink modules. Here we do the work ready for fitting: cut out, drainer grooves, even the undermount fixings all prepared for ready installation.

That's the **mariz** difference!



Surface: White Marble (WM)  
Sink: 10mm Radius Steel 1.5 Designer Bowl  
Tap: Twin Lever HS935 Brushed Steel



Carysil Sommelier Red Boost with Chrome Crown.

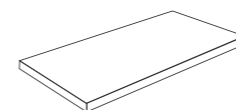

**FACTORY MACHINED FACE & EDGES, ALL FINISHED BY HAND**

**mariz** worksurfaces are supplied with the key edges ready prepared to ensure the quality of the finish.



**REDUCED TIME NEEDED ON SITE**

Less work to do at the final installation saves time and money.

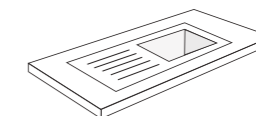

**PRE-FABRICATED FEATURES**

Undermounted bowls teamed with designer drainer grooves, breakfast bars, splashbacks and upstands, these are just some of the added attractions of choosing **mariz** for your kitchen.

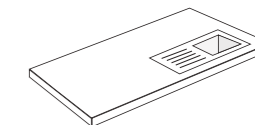

**CUSTOM SERVICE**

Rather than fabricating on-site, bespoke worktops can be manufactured within our factory for care free installation.



**CARYSIL**

# Eight on trend colourways

Available in eight colourways, market researched to complement all kitchens, **mariz** 12mm surfaces are both robust and easy to clean, giving you complete peace of mind with their superb performance and quality.

The core of the White Marble and White decors is white, while the Vena Black, Light Concrete, Dark Concrete, Antique Rust, Vena White and Deep Grey have a black core.

When you choose **mariz** surfaces you do so secure in the knowledge that you are buying a proven, reliable product. **mariz** surfaces are truly at the forefront of modern surface technology.



Surface: Light Concrete (LC)

**mariz** CARYSIL



mariz - white marble (WM)



mariz - vena black (VB)



mariz - light concrete (LC)



mariz - white (WH)



mariz - dark concrete (DC)



mariz - antique rust (AR)



mariz - vena white (VW)



mariz - deep grey (DG)

**Note:** All boards are double sided (same pattern either side). Ideal for shelves, breakfast bars and ensures both sides will be visible.



### Upstands

Install an upstand to simply extend your design from the worktop to the wall, creating a clean seal between horizontal and vertical surfaces.



### Splashbacks

Splashbacks are available in a variety of sizes and two thicknesses, ensuring a simple continuation of your decorative surface vertically and horizontally, both visually appealing and practical. For optimal installation, especially near or directly behind a hob, please refer to our comprehensive installation guidelines.



### Worktops

Offering unparalleled durability, our worktops are impervious to moisture, resistant to impact and heat providing long-lasting performance and are available in a wide selection of standard sizes complete with edge preparation.

Surface: Dark Concrete (DC)  
Sink: 10mm Radius Steel 1.5 Designer Bowl  
Tap: Twin Lever HS945 Brushed Steel



### Breakfast Bars

All eight décors are also available as a full island and breakfast bar, allowing you to create the true statement kitchen, perfect for relaxed dining or entertaining guests.



Surface: White Marble (WM)  
Sink: Granite 1.5 Designer Bowl in Graphite Grey

## Sink modules

One of the benefits of compact laminate is the ability to use undermounted sinks for a premium look and feel. One of the downsides is that cutting and preparing for the sink and drainer grooves can be an exacting and time-consuming process.

With the **mariz** selection of sink modules that work is already done to the highest standards in our factory. Each three metre worktop has the sink cutout and drainer grooves already prepared for any of our steel, ceramic and granite bowl options available in a variety of colours, all manufactured in our factory for complete product harmony.

The bowl or bowls of your choice are supplied along with the necessary fittings to simply screw the brackets into the prepared inserts.

Installation of one of our sink modules will typically be even quicker than fitting an overmount sink! For peace of mind all sinks are manufactured in our CARYSIL factories.

KEY:

 This sink is suitable for use with a boiling water tap

**500** Will fit into 500mm base cabinet

**600** Will fit into 600mm base cabinet

**650+** Will fit into base cabinet openings over 650mm

**S** All bowls are SS304 (18/10) grade steel



Granite Large Bowl in Black  
mariz antique rust (AR)



Ceramic Super Large Bowl  
mariz antique rust (AR)



10mm Radius Steel Ultra Large Bowl  
mariz dark concrete (DC)



25mm Radius Steel Super Large Bowl  
mariz dark concrete (DC)



Surface: White Marble (WM)  
Sink: Granite Super Large Bowl in Black



Surface: Antique Rust (AR)  
Sink: Ceramic Super Large Bowl

## Granite sinks

Our granite undermount selection offers great durability and a simple uncluttered design. Add the choice of four colourways and the options are plentiful. Complementing any worksurface, our granite sinks are manufactured with proven CARYSIL technology and come with a lifetime warranty.

- 12mm radius corners
- Plumbing kit supplied
- Boiling tap compatible
- Fitting clips supplied

### Single bowl

- a. 400mm
- b. 400mm
- c. 200mm

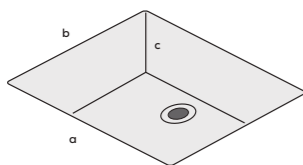

### Super large bowl

- a. 500mm
- b. 400mm
- c. 200mm

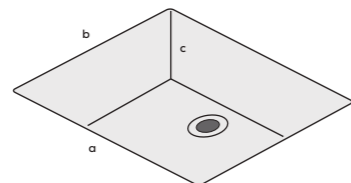

### 1.5 Designer reversible bowl

- a. 335mm
- b. 400mm
- c. 200mm
- d. 155mm
- e. 400mm
- f. 140mm

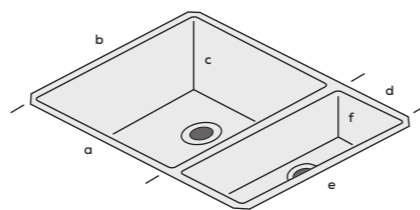

Available in the following colours



Black



White



Gunmetal



Graphite

## Ceramic sinks

Our ceramic sinks have been manufactured in our factory from the finest fireclay. Each sink is unique and hand-finished in brilliant white lustre with a high gloss glaze. Ultra-smooth, hard wearing and hygienic makes up just a few of the reasons that this selection of models will complement both traditional and contemporary kitchens alike.

- Ultra smooth, ultra hard & ultra hygienic
- Installation may require additional support
- FFC (Fine fireclay material) with hygienic glazed surface
- Boiling tap compatible

### Single bowl

- a. 390mm
- b. 390mm
- c. 195mm

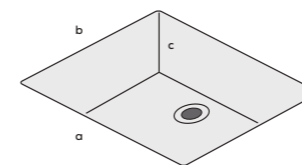

### Super large bowl

- a. 490mm
- b. 390mm
- c. 195mm

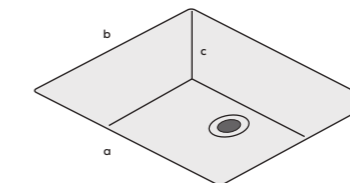

### 1.5 Designer bowl

- a. 330mm
- b. 390mm
- c. 195mm
- d. 155mm
- e. 390mm
- f. 140mm

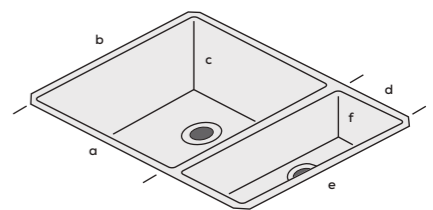



Surface: White Marble (WM)  
Sink: 10mm Steel 1.5 Designer Bowl LH/RH

## 10mm steel internal radius sinks

For a more contemporary feel look no further than our 10mm radius steel undermounts. The tight 10mm radius and pressed drainer channels give a clean modern feel and the simple drainer groove finish allows for the tap to be located to your own requirements. Manufactured in the CARYSIL factory, the surgical grade steel (SS304) offers longevity and durability, perfectly suited to complement our surfaces.

- 10mm radius corners
- Boiling tap compatible
- Plumbing kit supplied
- Fitting clips & sealant supplied

### Single bowl

- a. 340mm
- b. 400mm
- c. 190mm

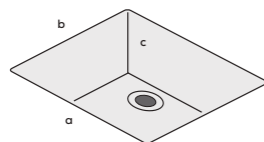

### Super large bowl

- a. 410mm
- b. 400mm
- c. 190mm

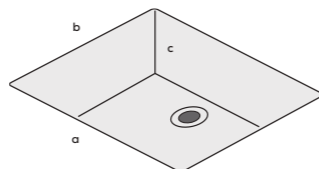

### Ultra large bowl

- a. 550mm
- b. 400mm
- c. 190mm

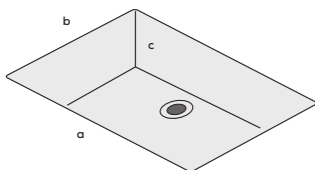

### 1.5 Duo bowl

- a. 340mm
- b. 400mm
- c. 190mm
- d. 180mm
- e. 400mm
- f. 125mm

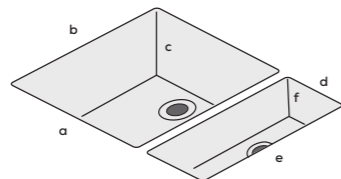

### 1.5 Designer bowl LH/RH

- a. 550mm
- b. 400mm
- c. 190mm
- d. 180mm
- e. 400mm
- f. 125mm

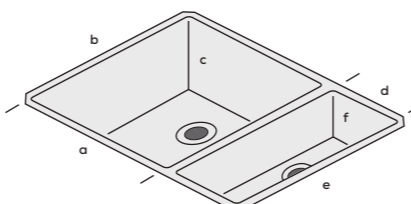

Surface: Deep Grey (DG)  
Sink: 25mm Steel 1.5 Designer Reversible Bowl

## 25mm steel internal radius sinks

This is our original range of undermounted steel sinks with a 25mm corner radius. The simple drainer groove patterns complement the bowls perfectly.

- 25mm radius corners
- Boiling tap compatible
- Plumbing kit supplied
- Fitting clips & sealant supplied

### Single bowl

- a. 340mm
- b. 400mm
- c. 190mm

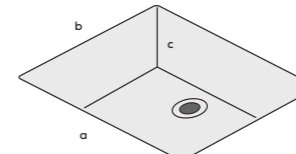

### Super large bowl

- a. 480mm
- b. 400mm
- c. 200mm

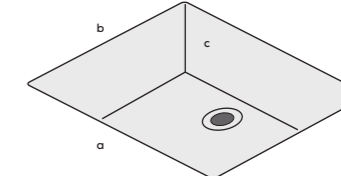

### 1.5 Designer reversible bowl

- a. 340mm
- b. 400mm
- c. 190mm
- d. 160mm
- e. 300mm
- f. 120mm

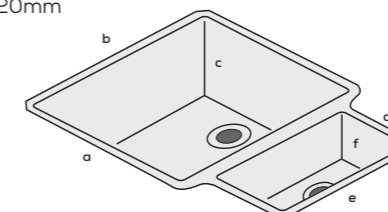

### 1.5 Large Designer reversible bowl

- a. 340mm
- b. 400mm
- c. 180mm
- d. 180mm
- e. 400mm
- f. 120mm

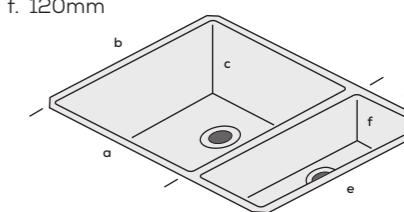



# Standard range and sizes

## Worksurfaces

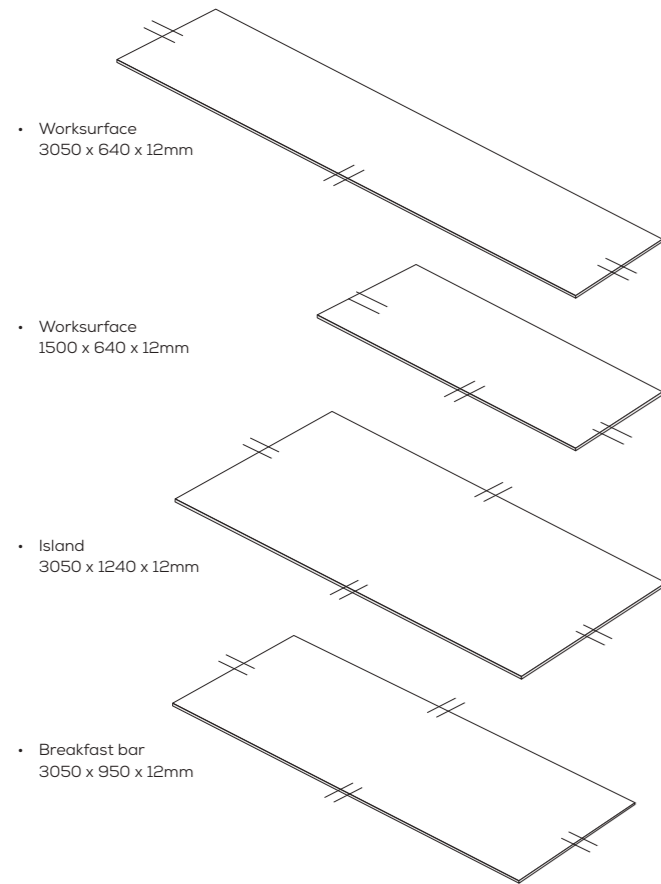

## Accessories

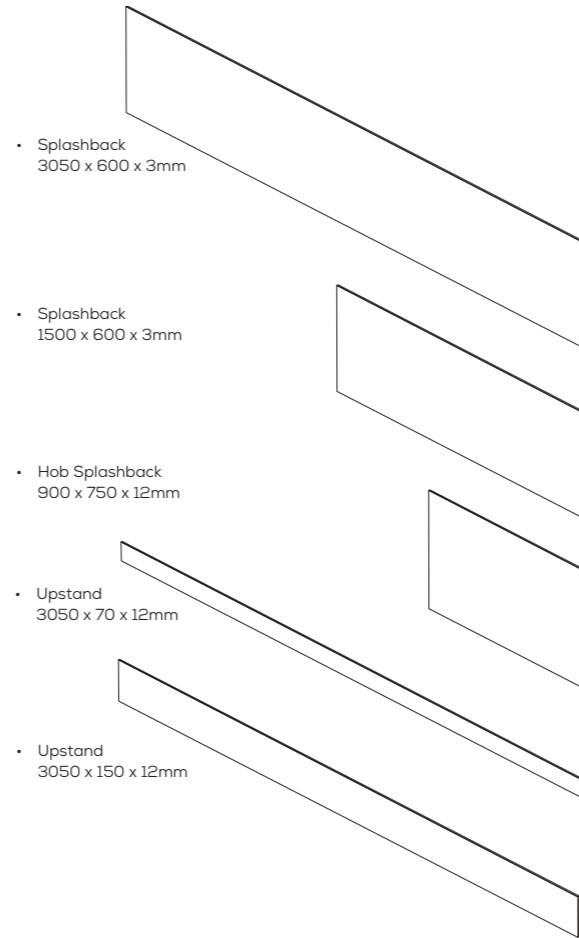

## Sink Modules

### Ceramic sinks

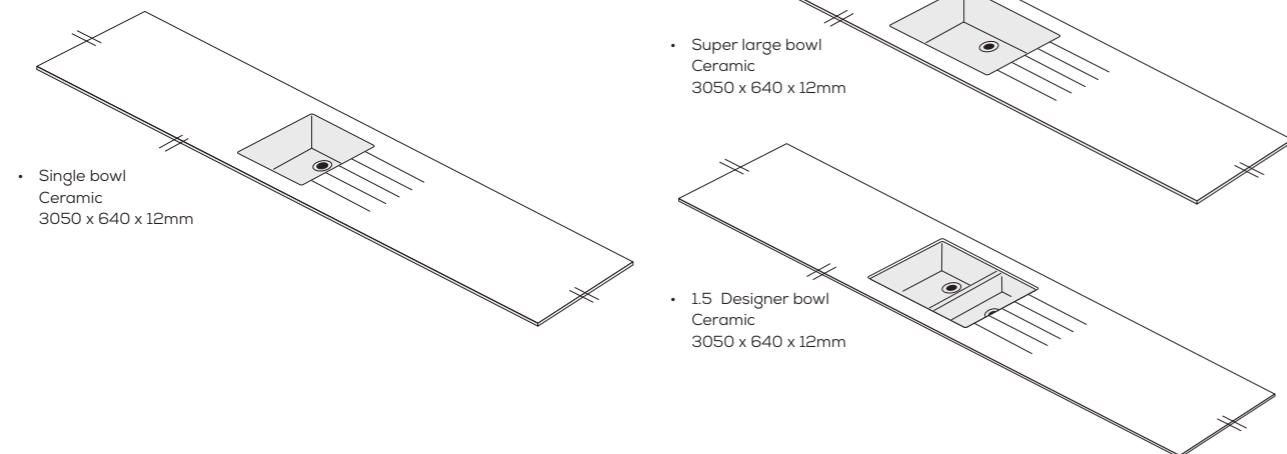

## Sink Modules

### Steel 25mm internal radius undermount sinks

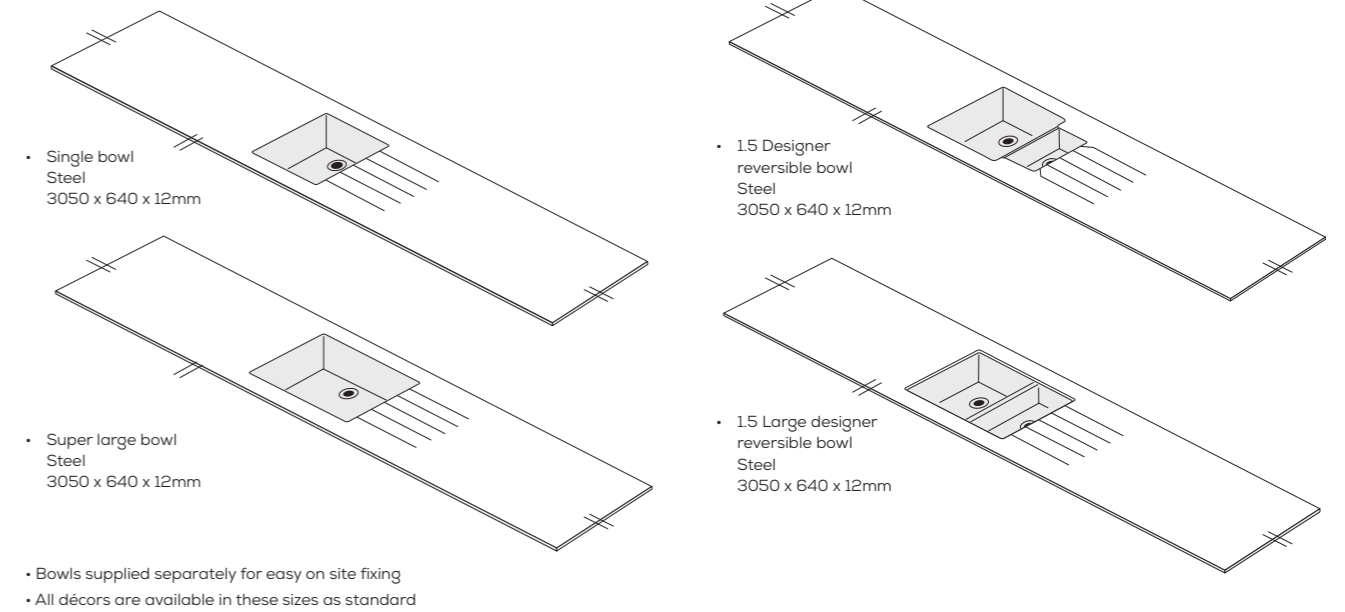

- Bowls supplied separately for easy on site fixing
- All décors are available in these sizes as standard

### Steel 10mm internal radius undermount sinks

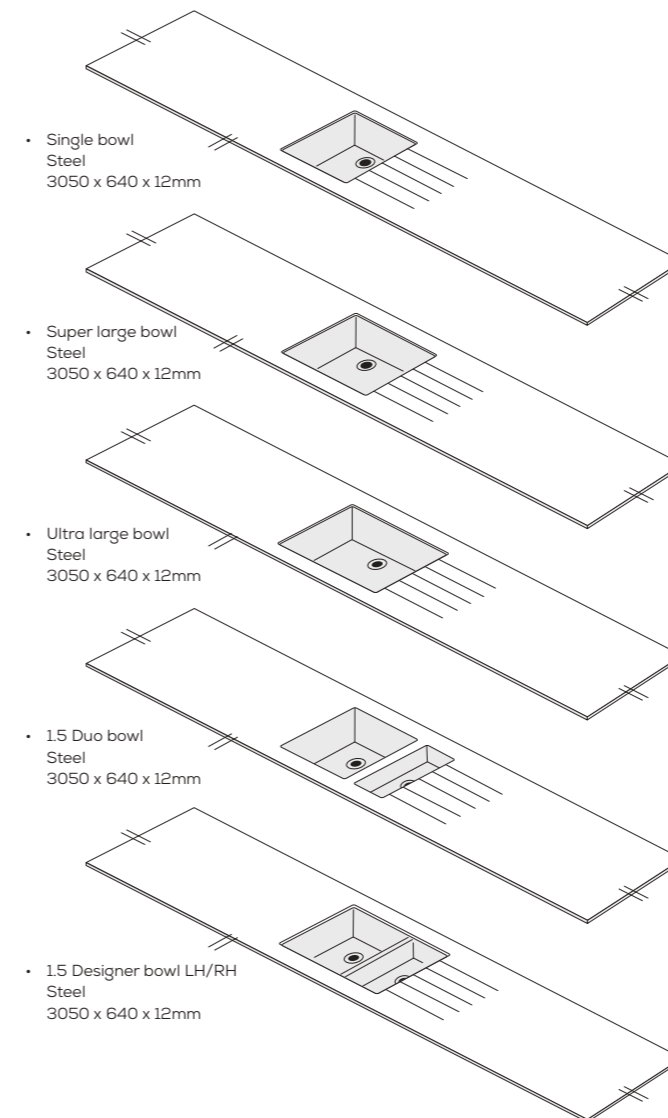

### Granite sinks

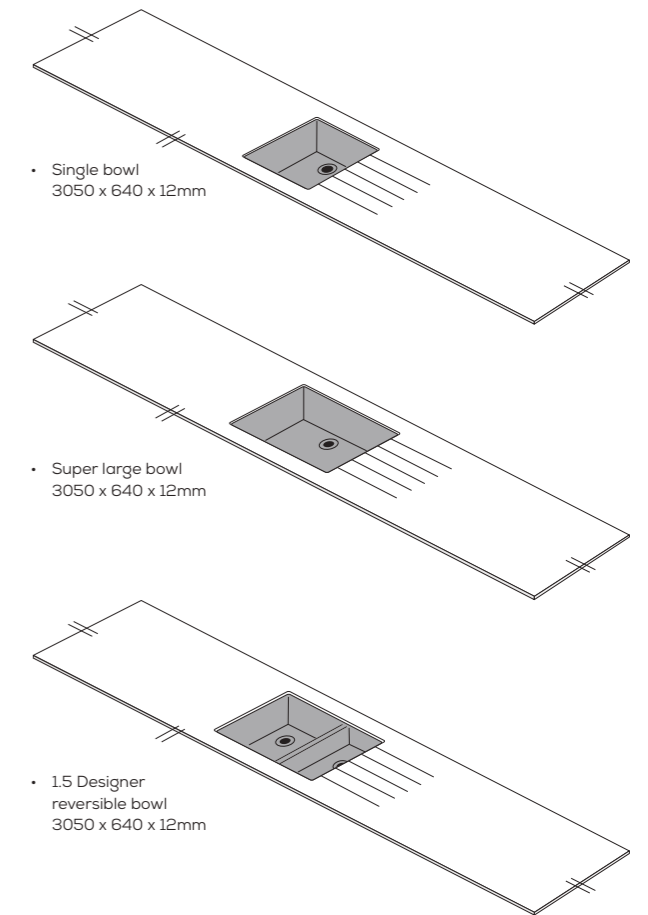

Factory finished edge

# mariz

## Technical

mariz worktops are 'Compact High Pressure Laminates' which meet the requirements of EN438. They are guaranteed for ten years against manufacturing defects provided they are fitted in accordance with the installation instructions and are used for their intended purpose.

### Routine cleaning

mariz worktops have a surface that makes cleaning simple. Usually a moist cloth is sufficient, but use washing-up liquid to get rid of any grease. Avoid using harsh cleaning equipment and abrasive cleaners as they may damage the surface. Stubborn dirt can be removed using mild solvents or proprietary glass cleaners.

For more detailed advice, there is a care & maintenance booklet in each worktop.

### Cutting and installing

mariz worktops can be cut and installed using conventional woodworking tools – always ensuring that cutters and blades are sharp. This will ensure clean edges for jointing or finishing. You can join Mariz surfaces using either a butt joint or mason's mitre using biscuit joints and adhesive.

We have a selection of adhesives to complement the mariz range of décors. These are available along with the mariz installation kit.

### Oven & hob Installation

mariz surfaces are compatible with most hobs although the 12.5mm thickness means that some adjustments may be necessary to ensure there is sufficient space between the hob and items beneath. For a single oven the cabinet shelf will usually be moved lower to give correct space for air circulation above.

Refer to appliance manufacturers instructions to ensure that correct clearances are achieved.



#### mariz Installation Kit

- Contains:
- 3 x Compact toggle bolts
- 3mm Hex key
- 3 x Biscuits
- 20ml Linseed oil
- Sanding block
- Sanding discs
- Grey Scotchbrite pad



#### mariz Adhesive kit

- Contains:
- 20ml adhesive tube
- and applicator

CARYSIL



# mariz



## CARYSIL

Carysil Surfaces Azalea Close Clover Nook Industrial Park  
Alfreton Derbyshire DE55 4QX

t 01773 521 300 e [surfacesales@carysil.co.uk](mailto:surfacesales@carysil.co.uk) [www.marizworksurfaces.co.uk](http://www.marizworksurfaces.co.uk)